

**BOURNS®**

### Features

- Standard E.I.A. package compatible with automatic placement equipment
- Tape and reel packaging standard (see page 304 for dimensions)
- For ordering guidelines, see page 304
- Marking on contrasting background for permanent identification

- Compliant leads to reduce solder joint fatiguing
- Standard electrical schematics: isolated, bussed, dual terminator
- Custom circuits are available

## 4800P Series - Thick Film Surface Mounted Medium Body

### Product Characteristics

#### Resistance Range

.....10 ohms to 2.2 megohms

Maximum Operating Voltage.....50V

Temperature Coefficient of Resistance

50Ω and above.....±100ppm/°C

below 50Ω.....±250ppm/°C

#### TCR Tracking

.....50ppm/°C max.; equal values

100ppm/°C 50W and above

#### Operating Temperature

.....-55°C to +125°C

#### Insulation Resistance

.....10,000 megohms min.

#### Dielectric Withstanding Voltage

.....200 VRMS

#### Lead Solderability

.....Meet requirements of MIL-STD-202

Method 208

### Environmental Characteristics

TESTS PER MIL-STD-202 .....ΔR MAX.

Short Time Overload.....±0.25%

Load Life.....±1.00%

Moisture Resistance.....±0.50%

Resistance to Soldering Heat.....±0.25%

Thermal Shock.....±0.25%

### Physical Characteristics

Flammability.....Conforms to UL94V-0

#### Lead Frame Material

.....Copper, solder coated

Body Material.....Novolac epoxy

### How To Order

48 16 P - 1 - 103

Model (48 = SOM Pkg)

Number of Pins

Electrical Configuration

- 1 or 4 = Isolated\*
- 2 = Bussed\*
- 3 = Dual Terminator\*

Resistance Code

- First 2 digits are significant
- Third digit represents the number of zeros to follow.

\*For tube packaging, use T01, T02, T03 or T04.

Consult factory for other available options.

### Package Power Temp. Derating Curve

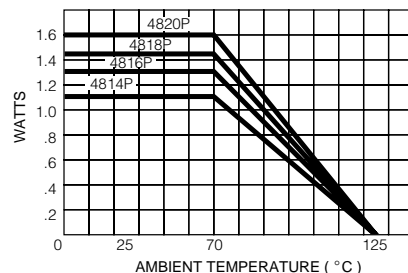

### Package Power Rating at 70°C

4814P	1.12 watts
4816P	1.28 watts
4818P	1.44 watts
4820P	1.60 watts

### Typical Part Marking

Represents total content. Layout may vary.

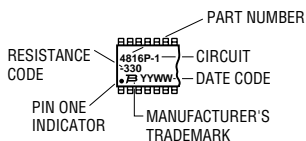

### Recommended Land Pattern

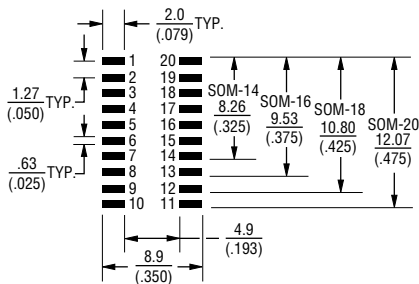

NOTE: Land pattern dimensions are based on design rules established by the Institute for Interconnecting and Packaging Electronic Circuits in IPC-SM-782.

### Product Dimensions

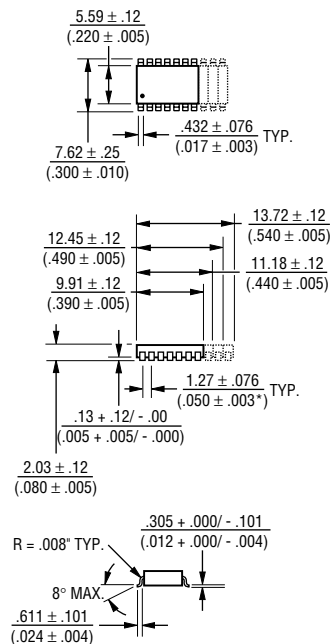

Lead coplanarity .102mm (.004 inch) max. at mounting surface.

Governing dimensions are in metric. Dimensions in parentheses are inches and are approximate.

\*Terminal centerline to centerline measurements made at point of emergence of the lead from the body.

# 4800P Series - Thick Film Surface Mounted Medium Body



## Isolated Resistors (1 And 4 Circuits)

Model 4814P-1  
 Model 4816P-1 (Shown)  
 Model 4818P-1  
 Model 4820P-1

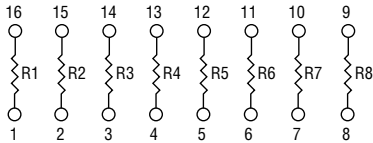

Model 4816P-4 (Shown)  
 Model 4820P-4

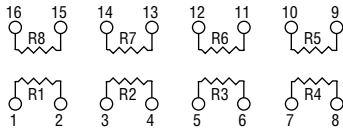

## Resistance Tolerance

10 ohms to 49 ohms .....±1 ohm  
 50 ohms to 2.2 megohms.....±2%\*

## Power Rating per Resistor

1 Circuit at 70°C .....0.160 watt  
 4 Circuit at 70°C .....0.160 watt

## Resistor Power Temp. Derating Curve

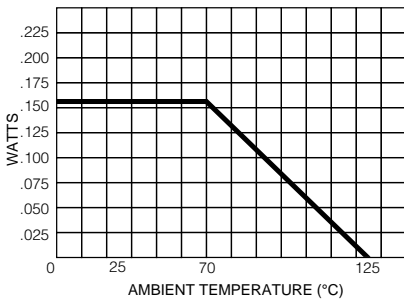

## Bussed Resistors (2 Circuit)

Model 4814P-2  
 Model 4816P-2 (Shown)  
 Model 4818P-2  
 Model 4820P-2

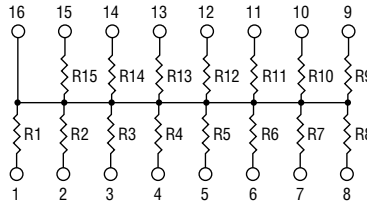

## Resistance Tolerance

10 ohms to 49 ohms .....±1 ohm  
 50 ohms to 2.2 megohms .....±2%\*

## Power Rating per Resistor

2 Circuit at 70°C .....0.080 watt

## Resistor Power Temp. Derating Curve

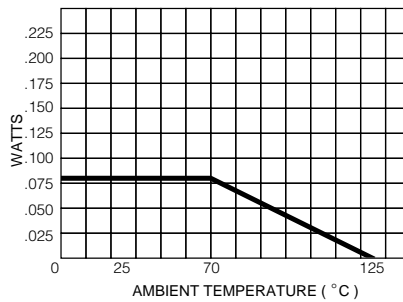

## Dual Terminator (3 Circuit)

Model 4814P-3  
 Model 4816P-3 (Shown)  
 Model 4818P-3  
 Model 4820P-3

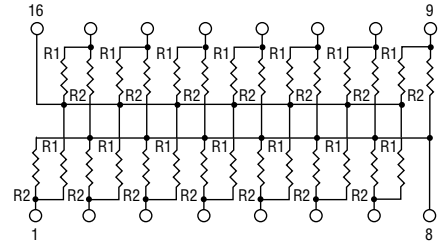

## Resistance Tolerance

Below 100 ohms .....±2 ohms  
 100 ohms to 2.2 megohms .....±2%\*

## Power Rating per Resistor

3 Circuit at 70°C .....0.080 watt

## Resistor Power Temp. Derating Curve

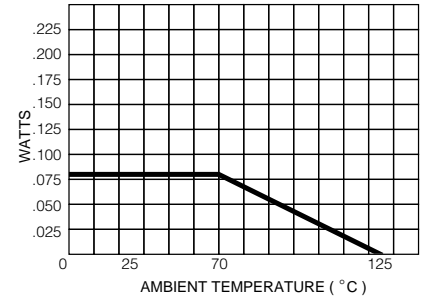

## Popular Resistance Values (1, 4, And 2 Circuits)\*\*

Ohms	Code	Ohms	Code	Ohms	Code	Ohms	Code	Ohms	Code
10	100	180	181	1,800	182	15,000	153	120,000	124
22	220	220	221	2,000	202	18,000	183	150,000	154
27	270	270	271	2,200	222	20,000	203	180,000	184
33	330	330	331	2,700	272	22,000	223	220,000	224
39	390	390	391	3,300	332	27,000	273	270,000	274
47	470	470	471	3,900	392	33,000	333	330,000	334
56	560	560	561	4,700	472	39,000	393	390,000	394
68	680	680	681	5,600	562	47,000	473	470,000	474
82	820	820	821	6,800	682	56,000	563	560,000	564
100	101	1,000	102	8,200	822	68,000	683	680,000	684
120	121	1,200	122	10,000	103	82,000	823	820,000	824
150	151	1,500	152	12,000	123	100,000	104	1,000,000	105

\* ±1% TOLERANCE IS AVAILABLE BY ADDING SUFFIX CODE "F" AFTER THE RESISTANCE CODE.

\*\*NON-STANDARD VALUES AVAILABLE, WITHIN RESISTANCE RANGE.

Specifications are subject to change without notice.

## Popular Resistance Values (3 Circuit)\*\*

Resistance			
(Ohms)		Code	
R <sub>1</sub>	R <sub>2</sub>	R <sub>1</sub>	R <sub>2</sub>
160	240	161	241
180	390	181	391
220	270	221	271
220	330	221	331
330	390	331	391
330	470	331	471
3,000	6,200	302	622

# Surface Mounted Ordering Guide



Electrical Configuration	*Circuit Codes		Examples
	Tape & Reel	Tubes	
Isolated	1	T01	4816P-1-101 Isolated Circuit in Tape & Reel Package
Bussed	2	T02	
Dual Terminated	3	T03	4816P-T01-101 Isolated Circuit in Slide Tube Package
Adj. Isolated	4	T04	

\*4816P-X-RC: To specify package type, replace "X" with appropriate "Circuit Code".

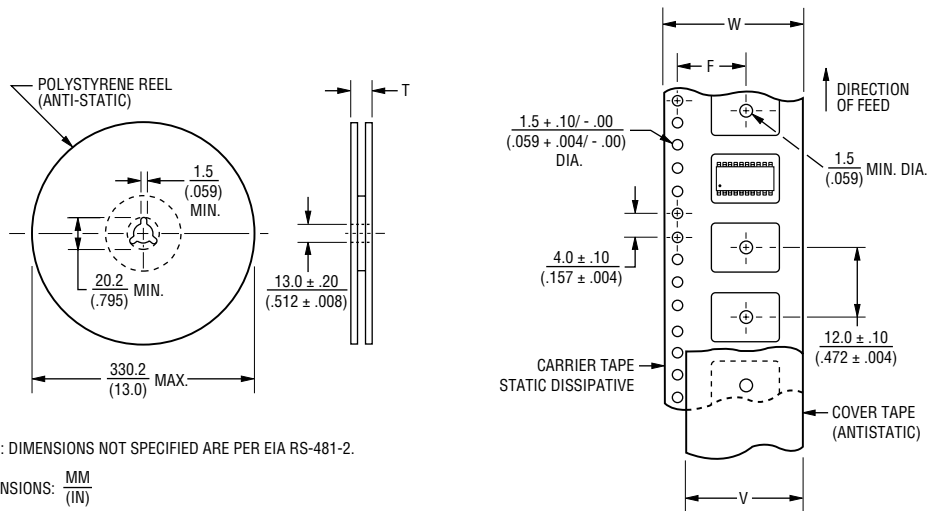

Model	Standard Quantity Per Reel	Carrier Tape Width (W)	Cover Tape Width (V)	Reel Width (T)	Pocket Center (F)
4416P	1,500	$24.0 \pm .30$ (.945 ± .012)	$21.0$ (.827) NOM.	$30.4$ (1.197) MAX.	$11.5 \pm .10$ (.453 ± .004)
4420P	1,500				
4814P 4816P 4818P 4820P	2,000				
4908P 4914P 4916P	2,500	12mm 12mm 16mm	Contact Factory	Contact Factory	8mm 8mm 8mm

Leader Length = 500 min.  
Trailer Length = 500mm min.



Empty Component Pockets  
Sealed with Cover Tape

# R/2R Ladder Networks



R/2R Ladder Networks are available in both DIP and SIP (Molded or Conformal) configurations.

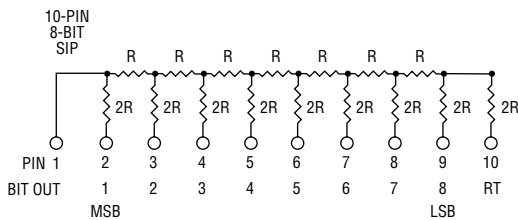
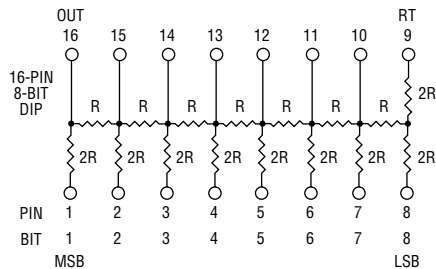

The R/2R Ladder Network is commonly used for Digital to Analog (D/A) conversions and Analog to Digital (A/D) conversion by successive approximations. The bits of the ladder are the points at which input signals are presented to the ladder and the output terminal (OUT) is the point at which the output is

taken from the R/2R ladder. This terminal (OUT) is commonly used to drive an operational amplifier.  $R_T$  (the terminating resistor) is always connected to ground.

Standard R/2R Ladder Networks have a resistance tolerance of  $\pm 2.0\%$  ( $\pm 1.0\%$  available on all but low profile SIPs).

### Standard R/2R Ladder Networks

Availability is as follows:

DIP/SMD	SIP-CONFORMAL	SIP MOLDED
14 Pin - 7 Bit	6 Pin - 4 Bit	6 Pin - 4 Bit
16 Pin - 8 Bit	7 Pin - 5 Bit	8 Pin - 6 Bit
	8 Pin - 6 Bit	10 Pin - 8 Bit
	9 Pin - 7 Bit	
	10 Pin - 8 Bit	
	11 Pin - 9 Bit	
	12 Pin - 10 Bit	
	14 Pin - 12 Bit	

### Resistor Power Ratings @ 70° C

Low Profile SIP & DIP	.125W
Medium Profile SIP	.170W
High Profile SIP	.200W

### How To Order R/2R Ladder Networks

41 16 R - R2R - 503

Model \_\_\_\_\_  
 (41 = Molded DIP)  
 (43 = Molded SIP)  
 (44 = Wide Body SMD)  
 (46 = Conformal SIP)  
 (48 = SMD)

Number of Pins \_\_\_\_\_

Physical Configuration \_\_\_\_\_  
 (R = Low Profile - Molded)  
 (X = Low Profile - Conformal)  
 (M = Medium Profile)  
 (H = High Profile)  
 (P = Medium Body SOIC)

Resistance/Capacitance Code  
 (For value of R). 2R is double this value.  
 • First 2 digits are significant.  
 • Third digit represents the number of zeros to follow.

Electrical Configuration  
 • R2R = R/2R Ladder Network